

ASSEMBLY GUIDE

STEP 3

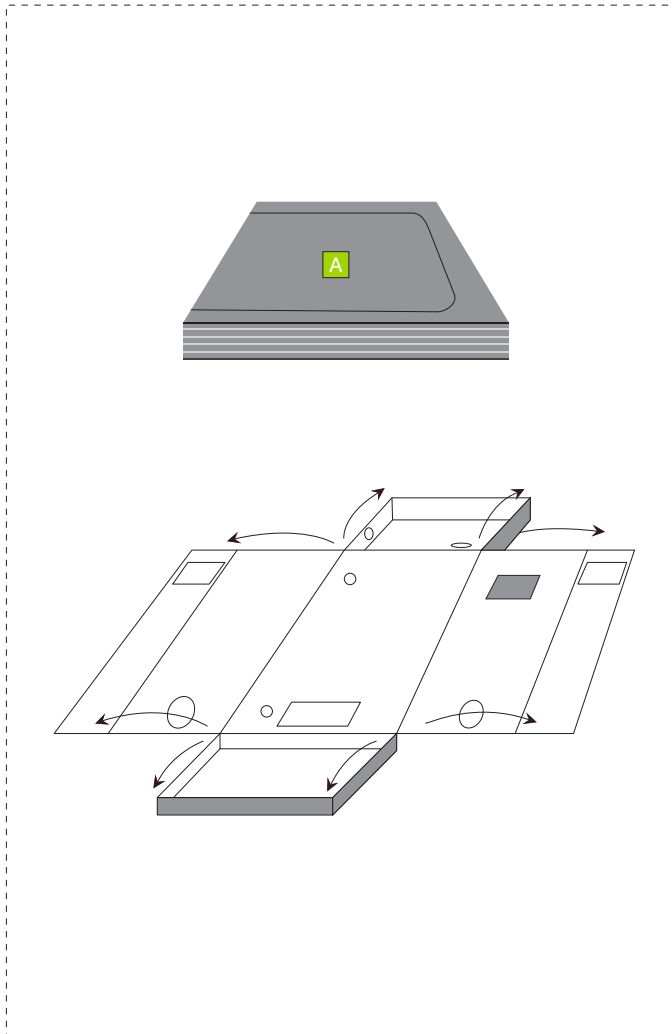

Lay out the grow tent canvas cover (A) on the floor. Place the tent frame on top of the canvas floor panel making sure that it is inserted the correct way.

ASSEMBLY GUIDE

STEP 4

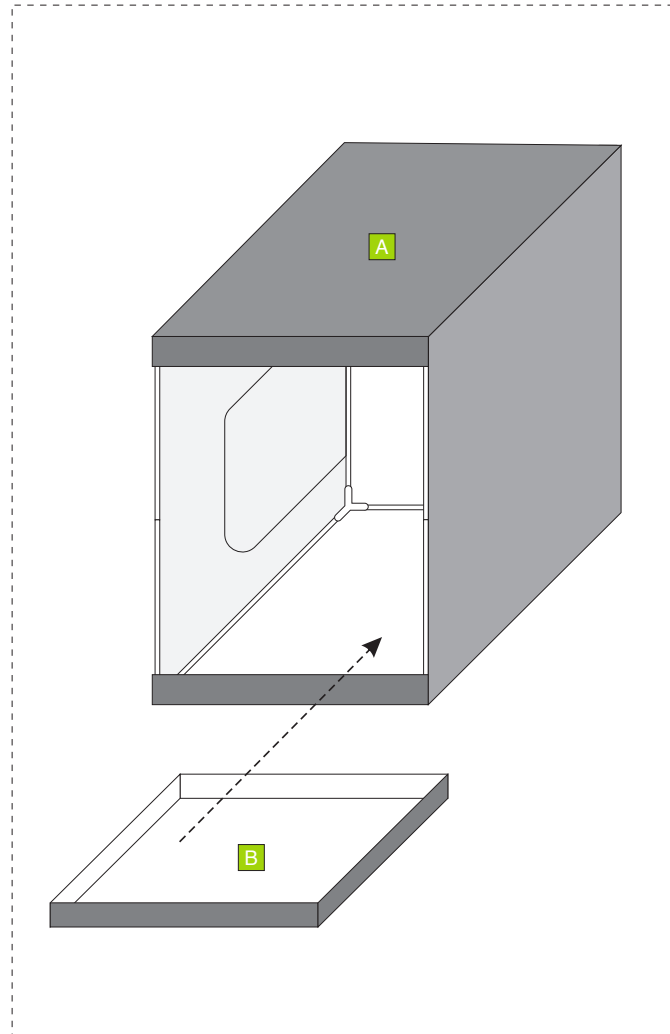

Carefully slip the canvas cover (A) onto the constructed frame and zip closed. Unzip the front door and place the floor tray (B) into the bottom of the tent.



MAGIC GARDEN TENT 150 x 150 x 200cm



150 x 150 x 200cm

CONTENTS

- (A) Tent
- (B) Floor Tray
- (C) Filter Straps
- (D) Corner Adapter

A 1 pcs

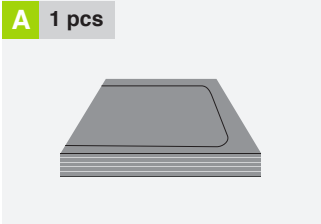

B 1 pcs

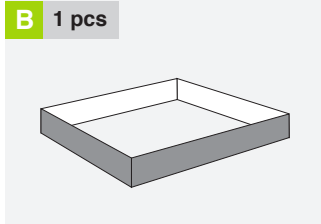

C 2 pcs

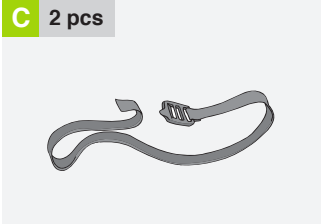

D 8 pcs

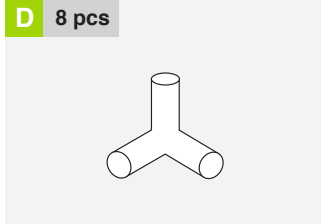

(1 - 5) Framework Support

- 1 8 pcs
- 2 4 pcs
- 3 4 pcs
- 4 2 pcs
- 5 2 pcs

ASSEMBLY GUIDE

STEP 1

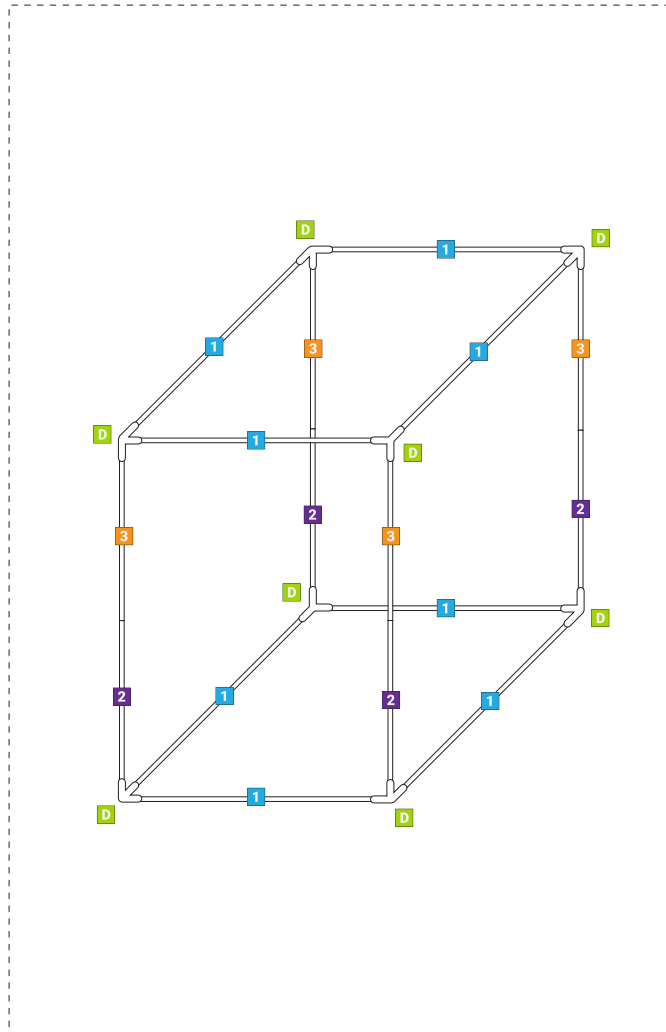

Assemble the frame by attaching the poles into the corner units (D) as shown above. Make sure that the poles are securely pressed into the corner unit, (you will hear a clicking sound).

ASSEMBLY GUIDE

STEP 2

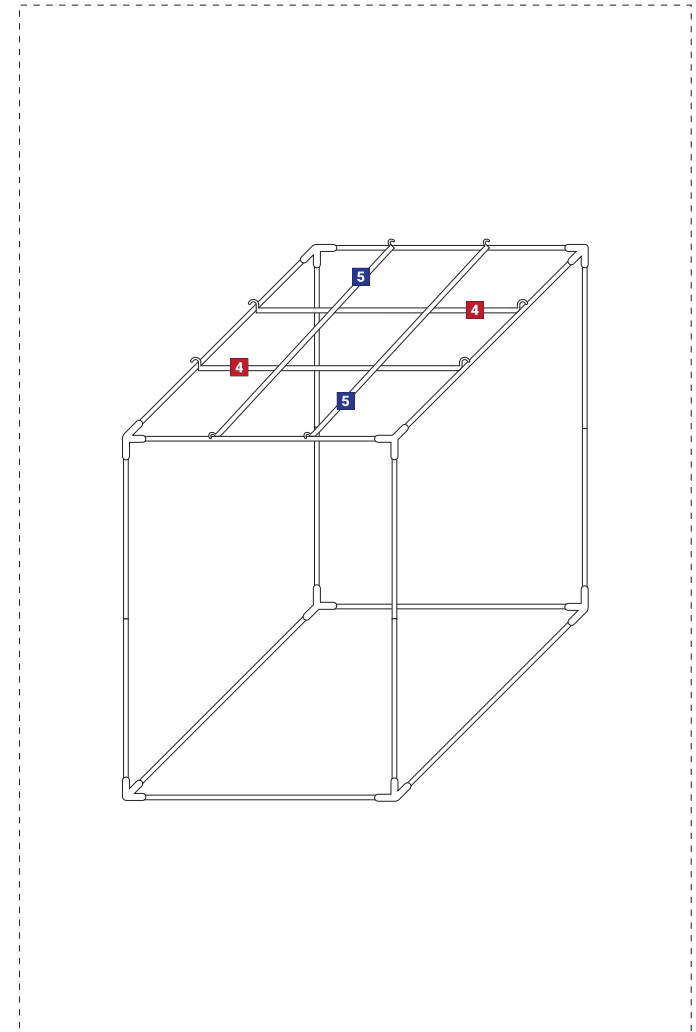

Fit the ceiling hanging bars inside the tent as shown. Insert (4) first and then place (5) on top. These poles can be moved around to accommodate for different equipment.